

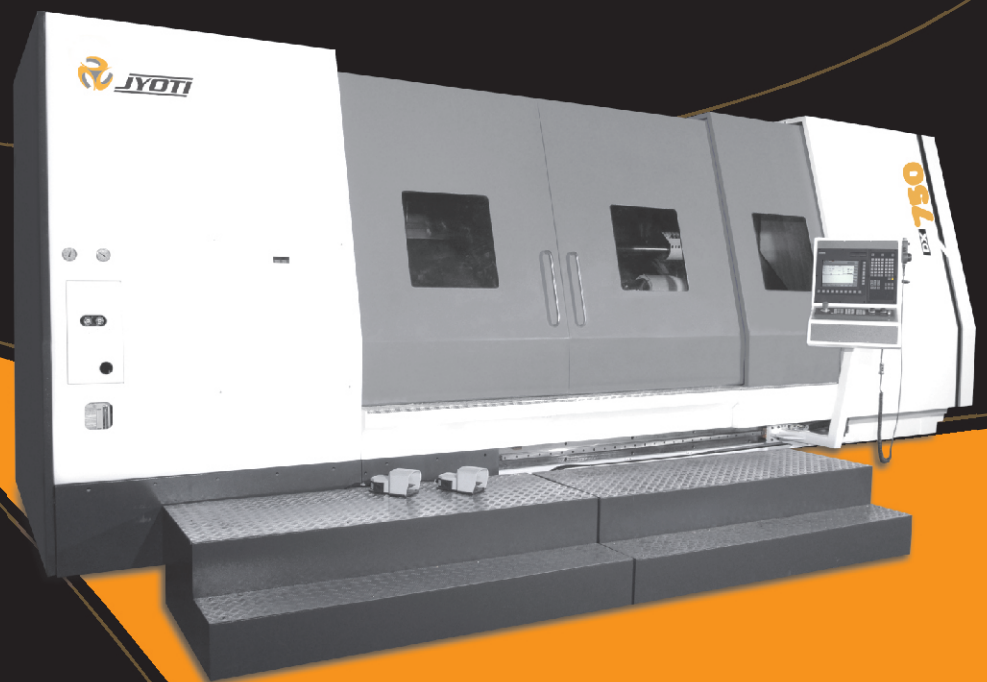

# DX Large Series

CNC Turning Centers



# DX Large Series

CNC Turning Center

## OVERVIEW

DX Large Series CNC turning centers are the most robust machines designed for heavy & interrupted cutting thereby letting you to achieve superior finishing & retains long term accuracies in conjunction with ease of service, excellent maintainability & flexibility. This Series is an ideal partner for machining large diameter components used in automotive and sub-contracting industries. The machines are thermally stable to meet your production demands.

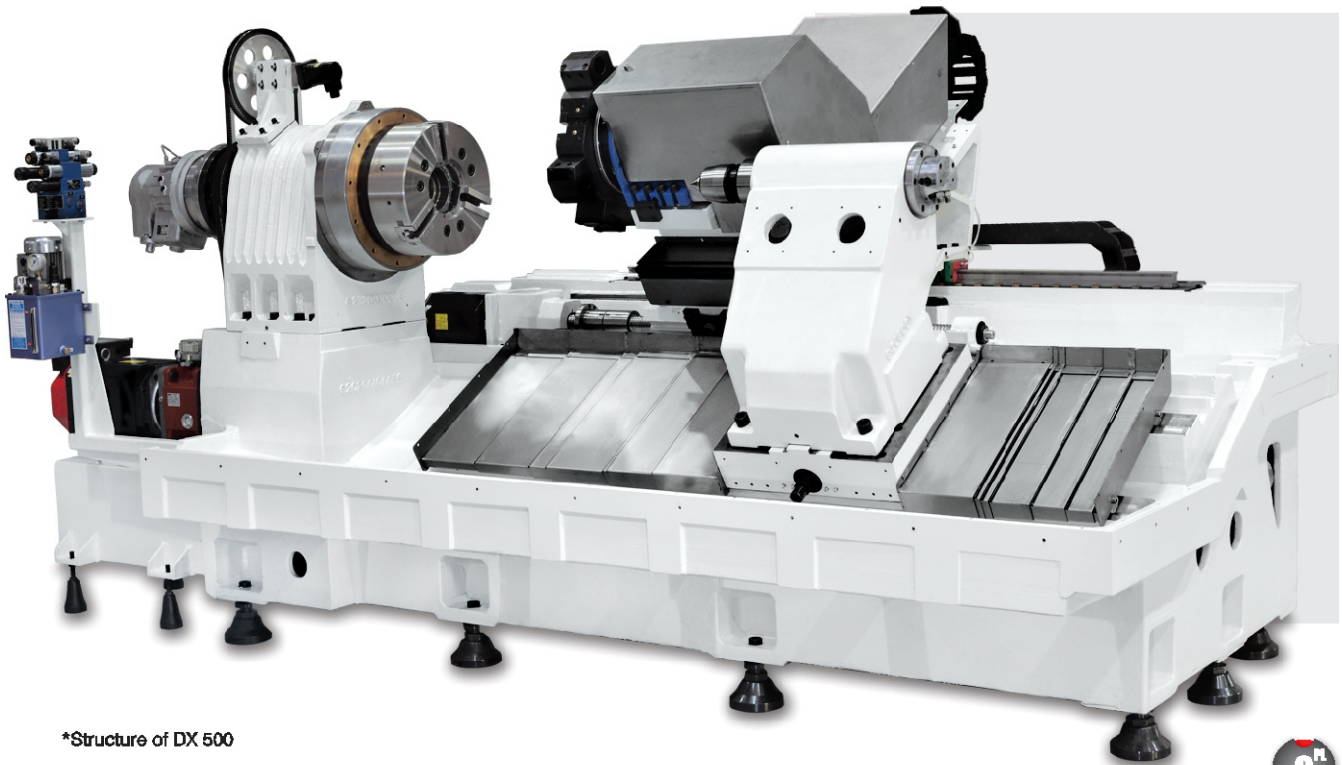

\*Structure of DX 500

## RIGID STRUCTURE

DX 500 has the robust bed & single piece 30° slant Saddle Construction, is designed for high speed & to withstand heavy-duty process forces. The Bed & Saddle are made of higher grade cast iron provides maximum rigidity, thermal stability, damping & least distortion which makes it most suitable for hard part turning.

Step-up Structure concept with widely spaced guideways enables consistent machining performance even at bigger diameter.

Finite Element Analysis Techniques were deployed to design a rigid & structurally optimized machine resulting in superior damping characteristics which minimizes the vibrations occurring during the heavy interrupted metal cutting operations.

## 3 - POINT LEVELING

Structural design followed with the concept of 3 PL provides it with higher base rigidity due to which twisting of bed is eliminated during actual working load conditions. Also this feature enables machine to be installed and re-located quickly and easily.



## HEAD STOCK

Taking into consideration ability to take heavy cutting loads, the head stock is made from closed grain FG 300 grade casting. Fins are provided with better surface area for proper heat dissipation enabling better spindle life.

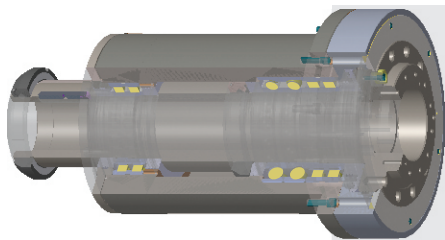
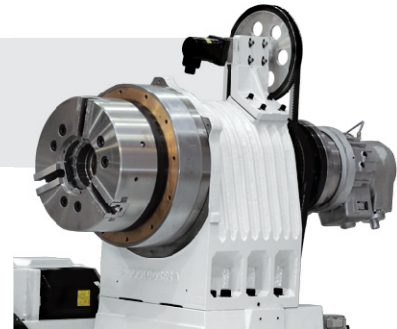

## RIGID SPINDLE

Machine spindle is manufactured in-house with the help of world class precision mother machineries and assembled in a dust free temperature controlled environment.. In A<sub>2</sub>11 Spindle, the design is with 1 cylindrical roller bearings + 2 angular contact bearings at the front and 1 cylindrical roller bearing at the rear for efficient working. This arrangement takes care of radial as well as axial loads. Powerful spindle with High Torque Motor allow high material removal rate.

## RIGID SERVO TURRET

DX Series machine are equipped with high speed and high precision Bi-directional Servo Turret with hydraulic clamping system achieved by 3-piece hirth coupling.

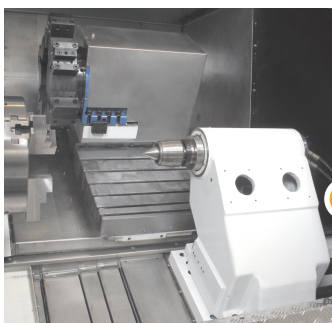
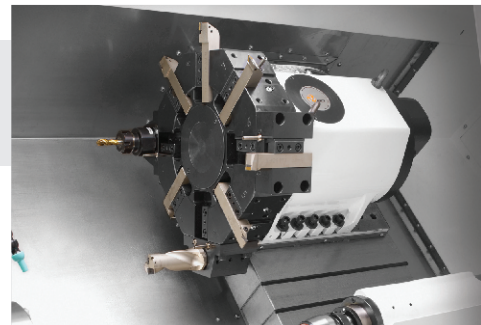

## TAIL STOCK

A manually movable tailstock with hydraulically actuated quill is a standard feature of the machine. Digital tailstock driven by servo motor or Programmable tailstock with hydraulic movement is offered as an option.

## LINEAR AXIS

Machines are fully capable to take higher cutting parameters even with hard turning materials thanks to wide Linear Motion (Roller type) Guideways, Preloaded direct coupled ball-screws and Monoblock

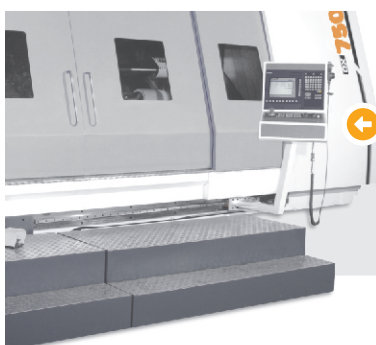

## OPERATOR PANEL

The movable and rotating operator panel is designed considering the reliability and the operator friendliness.

# DX Large Series

CNC Turning Center

## PRODUCTIVITY IMPROVING OPTIONS

### TURN MILL CENTER



### LIVE TOOL TURRET

Standard VDI or BMT servo driven 12 tool station indexing turret on Turnmill Centers allows combination of the static or powered tools. Each Turret movement is controlled by High-Torque servo motor for various milling applications.

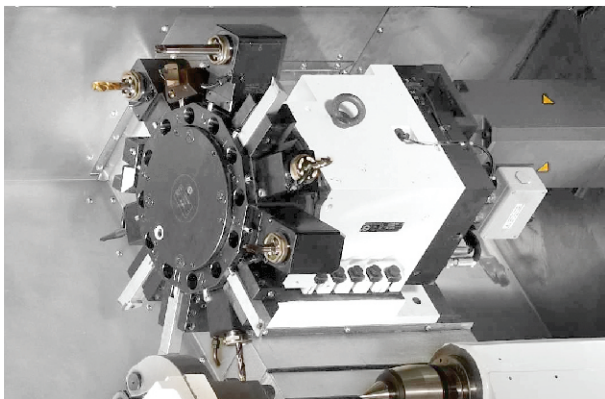

### HEAD STOCK WITH C-AXIS

TMC available with hydraulically operated disc brake for C-Axis which is helpful for milling operations like PCD Drilling and Tapping, OD & ID profiles with Radial and Axial Live tools.

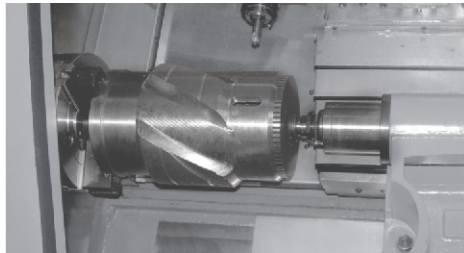
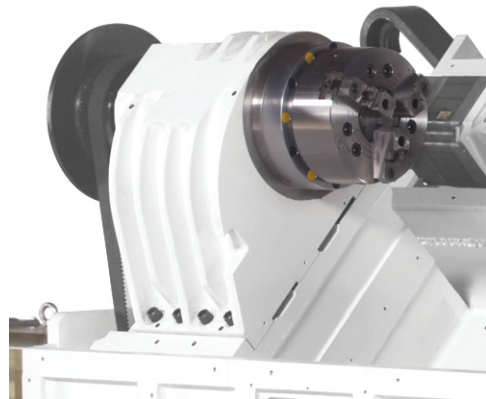



## HYDRAULIC STEADY REST

Machine can be equipped with hydraulic steady rest for smooth machining operation for over-hang work pieces as per required applications.

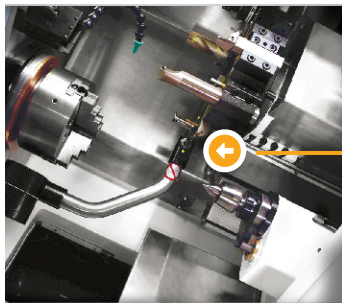

## AUTOMATIC TOOL SETTING

Automatic Tool Setting Probes and Job Probe can be incorporated with control feedback to set accurate tool data and even detect in-process tool wear or breakages.

## GEARBOX

Auto Shifting 2-Speed Gearbox can be selected for applications requiring high cutting force for hard material or high cutting speed for softer materials providing high cutting torque at lower rpm.

## DIGITAL TAIL STOCK

The highly rigid tailstock is driven by a servo motor and moved on Linear Motion guides. A digital tailstock with variable speed, feed control allows separate speeds to be set for approach and engagement, reducing the operating time of the tailstock spindle by over 20%.

## POWER TORQUE DIAGRAM

22 / 18.5 kW (Fanuc)

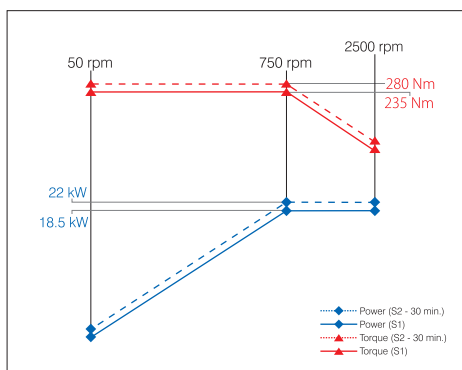

26 / 22 kW (Fanuc)

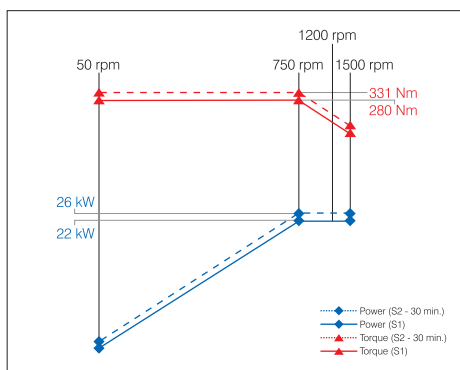

37 / 30 kW (Fanuc)

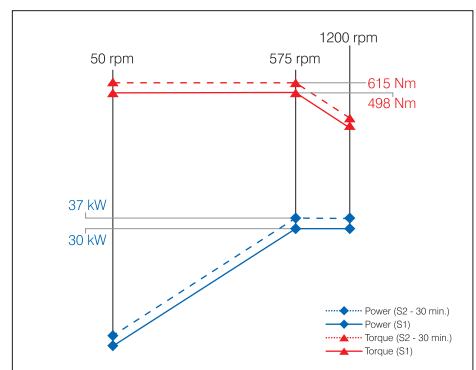

27.8 / 18.5 kW (Siemens)

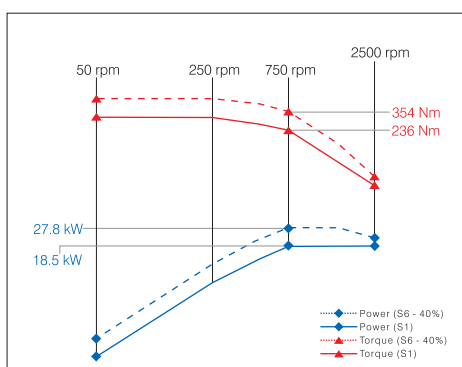

33 / 22 kW (Siemens)

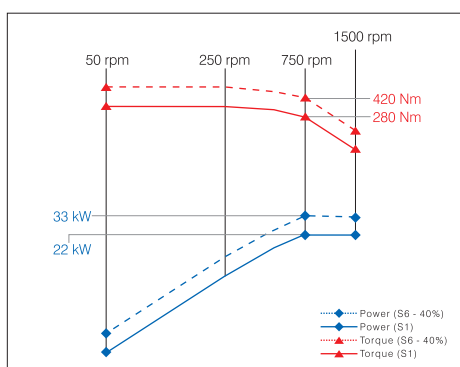

45 / 30 kW (Siemens)

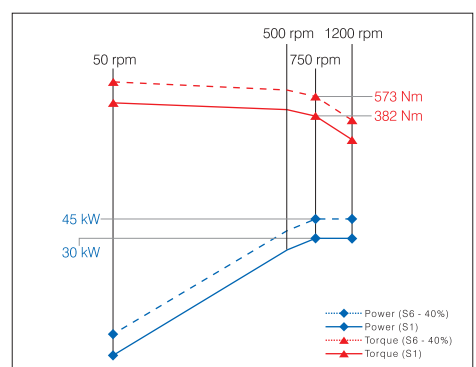



## TECHNICAL SPECIFICATION

Capacity		DX 500 - 1000 A	DX 500 - 1000 B	DX 500 - 1000 C	DX 500 - 1250 A	DX 500 - 1250 B	DX 500 - 1250 C	DX 500 - 2000 A	DX 500 - 2000 B	DX 500 - 2000 C	DX 750 - 1250 A	DX 750 - 1250 B	DX 750 - 3000 A	DX 750 - 3000 B	
Swing Over Bed	mm	800	800	800	825	825	825	825	825	825	1050	1050	1050	1050	
Std. Turning Dia.	mm	550	550	550	600	600	600	600	600	600	770	770	770	770	
Max. Turning Dia.*	mm	700	700	700	800	800	800	800	800	800	920	920	920	920	
Max. Turning Length*	mm	1000	1000	1000	1250	1250	1250	2000	2000	2000	1250	1250	3000	3000	
<b>Slides</b>															
X-Axis Travel (Cross)	mm	360	360	360	410	410	410	410	410	410	480	480	480	480	
Z-Axis Travel (Longitudinal)	mm	1000	1000	1000	1250	1250	1250	2000	2000	2000	1250	1250	3100	3100	
Rapid Feed (X & Z Axis)	m/min	24	24	24	24	24	24	24	24	24	24	24	24 / 20	24 / 20	
<b>Main Spindle</b>															
Spindle Motor Power - Fanuc	kW	22 / 18.5	26 / 22	37 / 30	22 / 18.5	26 / 22	37 / 30	22 / 18.5	26 / 22	37 / 30	26 / 22	37 / 30	26 / 22	37 / 30	
Spindle Motor Power - Siemens	kW	27.8 / 18.5	33 / 22	45 / 30	27.8 / 18.5	33 / 22	45 / 30	27.8 / 18.5	33 / 22	45 / 30	33 / 22	45 / 30	33 / 22	45 / 30	
Spindle Speed Range	rpm	50-2500	50-1500	50-1200	50-2500	50-1500	50-1200	50-2500	50-1500	50-1200	50-1500	50-1200	50-1500	50-1200	
Spindle Bore	mm	80	110	180	80	110	180	80	110	180	110	180	110	180	
Spindle Nose		A <sub>2</sub> 8	A <sub>2</sub> 11	A <sub>2</sub> 15	A <sub>2</sub> 8	A <sub>2</sub> 11	A <sub>2</sub> 15	A <sub>2</sub> 8	A <sub>2</sub> 11	A <sub>2</sub> 15	A <sub>2</sub> 11	A <sub>2</sub> 15	A <sub>2</sub> 11	A <sub>2</sub> 15	
Max. Bar Capacity	mm	65	90	90	65	90	90	65	90	90	90	90	90	90	
<b>Turret</b>															
No. of Station		8	8	8	8	8	8	8	8	8	12	12	12	12	
Max. Boring Bar Dia.	mm	50	50	50	50	50	50	50	50	50	60	60	60	60	
Tool Size (Cross Sectional)	mm	32 X 32	32 X 32	32 X 32	32 X 32	32 X 32	32 X 32	32 X 32	32 X 32	32 X 32	40 X 40	40 X 40	40 X 40	40 X 40	
<b>Tail Stock</b>															
Quill Dia.	mm	130	130	130	130	130	130	130	130	130	170	170	170	170	
Quill Stroke	mm	150	150	150	150	150	150	150	150	150	200	200	200	200	
Thrust (Adjustable)	kgf (Max.)	1000	1000	1000	1000	1000	1000	1000	1000	1000	1500	1500	1500	1500	
<b>Accuracy (as per VDI/DGQ 3441)</b>															
Positioning Uncertainty (P) (X / Z Axis)	mm	0.01	0.01	0.01	0.01 / 0.015	0.01 / 0.015	0.01 / 0.015	0.01 / 0.015	0.01 / 0.015	0.01 / 0.015	0.01 / 0.015	0.01 / 0.015	0.01 / 0.02	0.01 / 0.02	
Repeatability (Ps Medium) (X / Z Axis)	mm	0.005	0.005	0.005	0.005 / 0.007	0.005 / 0.007	0.005 / 0.007	0.005 / 0.007	0.005 / 0.007	0.005 / 0.007	0.005 / 0.007	0.005 / 0.007	0.005 / 0.008	0.005 / 0.008	
<b>Other Data</b>															
Weight (Approx.)	kg	9500	9500	9500	10000	10000	10000	12500	12500	12500	19500	19500	24000	24000	
Machine Dimension (Approx.)#															
Length	mm	5500	5500	5500	5875	5875	5875	6930	6930	6930	7175	7175	9120	9120	
Width	mm	2860	2860	2860	2860	2860	2860	2940	2940	2940	4420	4420	4420	4420	
Height	mm	2250	2250	2250	2250	2250	2250	2250	2250	2250	2900	2900	2900	2900	

\* Depends upon clamping arrangement, Tooling and Job. # Refer Machine Detailed Layout for overall machine dimensions & space requirements.

### CONTROL SYSTEM

The CNC System offered with the DX series machine is the latest digital control from FANUC Oi TF or SIEMENS 828D Basic T.

### STANDARD FEATURES

- AC Spindle Drive
- AC Servo Digital Drive
- Monoblock Structure
- 8-Station Bi-Directional Servo Turret
- L. M. Guideways (Roller Type)
- Hydraulic Chucking
- Auto & Manual Coolant System
- Centralised & Programmable Lubrication
- Laser Calibrated Axis
- Electricals with Quality Devices & Panel with A. C.
- Tailstock with Hydraulic Quill
- Chip Conveyor

### PRODUCTIVITY IMPROVEMENT OPTIONS

- Two Speed Gear Box
- Bar Feeder
- Steady Rest
- Large Spindle Bore
- Automatic Tool Setting
- Job Probe
- Digital Tailstock
- Auto Door
- Bar Puller
- Live Quill (Built-in Revolving Center)
- Automatic Loading Unloading System
- 12 Station Turret
- Hydraulic Collet Chuck
- Manual Guide i (Fanuc)
- Shop Turn (Siemens)
- Easy SMS System (Siemens)
- Fully Toolled up Solution to Meet Customer Needs

**JYOTI CNC AUTOMATION LTD.**

[jyoti.co.in](http://jyoti.co.in)

**Regd.Works:** Plot No.,G-506, Lodhika GIDC, Vill.-Metoda, Dist.-Rajkot - 360 021.

Gujarat (India) **T** +91-2827-306100-101 **F** +91-2827-306141

**E** [info@jyoti.co.in](mailto:info@jyoti.co.in), [sales@jyoti.co.in](mailto:sales@jyoti.co.in)

Download the  
App



GET IT ON  
**Google Play**

Download on the  
**App Store**

Note: Specified information are subject to change arising out of continuous product improvement without notice. The description standard accessories/feature conforms to its list; not the photo of machine show in the catalogue. Other controller will have different configuration. Machine images are shown with option.



ISO 9001 : 2008